

150V N-Channel Enhancement Mode MOSFET

General Features

- ESD Improved Capability
- Proprietary Advanced Planar Technology
- Rugged Polysilicon Gate Cell Structure
- Fast Switching Speed
- RoHS Compliant
- Halogen-free Available

BV_{DSX}	$R_{DS(ON)}$ (Typ.)	I_D
150V	5 Ω	0.35A

SOT-223

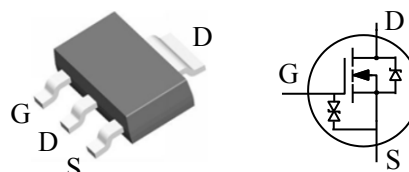

Applications

- Relay Driver
- High Speed Line Driver
- Logic Level Translator

Ordering Information

Part Number	Package	Marking	Remark
FTS10N15G	SOT-223	10N15G	Halogen Free

Absolute Maximum Ratings

$T_A = 25^\circ\text{C}$ unless otherwise specified

Symbol	Parameter	FTS10N15G	Unit
V_{DSX}	Drain-to-Source Voltage ^[1]	150	V
V_{DGX}	Drain-to-Gate Voltage ^[1]	150	V
I_D	Continuous Drain Current	0.35	A
I_{DM}	Pulsed Drain Current ^[2]	1.4	
P_D	Power Dissipation	1.5	W
	Derating Factor above 25°C	0.012	W/ $^\circ\text{C}$
V_{GS}	Gate-to-Source Voltage	± 20	V
$V_{ESD(G-S)}$	Gate-to-Source ESD IEC, C=150pF, R=330 Ω	2500	V
T_L	Soldering Temperature Distance of 1.6mm from case for 10 seconds	300	$^\circ\text{C}$
T_J and T_{STG}	Operating and Storage Temperature Range	-55 to 150	

Caution: Stresses greater than those listed in the "Absolute Maximum Ratings" may cause permanent damage to the device.

Thermal Characteristics

Symbol	Parameter	FTS10N15G	Unit
$R_{\theta JA}$	Thermal Resistance, Junction-to-Ambient	83.3	$^\circ\text{C}/\text{W}$

Electrical Characteristics

OFF Characteristics

 $T_A = 25^\circ\text{C}$ unless otherwise specified

Symbol	Parameter	Min.	Typ.	Max.	Unit	Test Conditions
BV_{DSX}	Drain-to-Source Breakdown Voltage	150	--	--	V	$V_{GS}=0V, I_D=250\mu A$
$\Delta BV_{DSS}/\Delta T_J$	Breakdown Voltage Temperature Coefficient	--	0.15	--	V/°C	Reference to 25°C , $I_D=250\mu A$
I_{DSS}	Drain-to-Source Leakage Current	--	--	1	μA	$V_{DS}=150V, V_{GS}=0V$
		--	--	100	μA	$V_{DS}=120V, V_{GS}=0V$ $T_J=125^\circ\text{C}$
I_{GSS}	Gate-to-Source Leakage Current	--	--	10	μA	$V_{GS}=+20V, V_{DS}=0V$
		--	--	-10		$V_{GS}=-20V, V_{DS}=0V$

ON Characteristics

 $T_A = 25^\circ\text{C}$ unless otherwise specified

Symbol	Parameter	Min.	Typ.	Max.	Unit	Test Conditions
$R_{DS(ON)}$	Static Drain-to-Source On-Resistance	--	5	10	Ω	$V_{GS}=10V, I_D=250mA$ [3]
$V_{GS(th)}$	Gate Threshold Voltage	1.5	--	2.5	V	$V_{GD}=0V, I_D=250\mu A$
gfs	Forward Transconductance	--	360	--	mS	$V_{DS}=5V, I_D=175mA$ [3]

Dynamic Characteristics

Essentially independent of operating temperature

Symbol	Parameter	Min.	Typ.	Max.	Unit	Test Conditions
C_{ISS}	Input Capacitance	--	32.8	--	pF	$V_{GS}=0V$ $V_{DS}=10V$ $f=1.0MHz$
C_{OSS}	Output Capacitance	--	17.2	--		
C_{RSS}	Reverse Transfer Capacitance	--	4.6	--		
Q_G	Total Gate Charge	--	1.2	--	nC	$V_{DS}=60V$ $I_D=250mA$ $V_{GS}=5V$
Q_{GS}	Gate-to-Source Charge	--	0.4	--		
Q_{GD}	Gate-to-Drain (Miller) Charge	--	0.7	--		

Resistive Switching Characteristics

Essentially independent of operating temperature

Symbol	Parameter	Min.	Typ.	Max.	Unit	Test Conditions
$t_{d(on)}$	Turn-on Delay Time	--	3.6	--	ns	$V_{DD}=50V$ $R_D=250\Omega$ $R_G=50\Omega$ $V_{GS}=10V$
t_{rise}	Rise Time	--	7.2	--		
$t_{d(off)}$	Turn-off Delay Time	--	16.0	--		
t_{fall}	Fall Time	--	36.8	--		

Source-Drain Diode Characteristics
 $T_A = 25^\circ\text{C}$ unless otherwise specified

Symbol	Parameter	Min	Typ.	Max.	Unit	Test Conditions
V_{SD}	Diode Forward Voltage	--	--	1.5	V	$I_{SD}=300\text{mA}$, $V_{GS}=0\text{V}$
I_{SD}	Continuous Source Current (Body Diode)	--	--	0.5	A	Integral P-N diode in MOSFET
I_{SM}	Maximum Pulsed Current (Body Diode)	--	--	2.0	A	

NOTE:

[1] $T_J = +25^\circ\text{C}$ to $+150^\circ\text{C}$

[2] Repetitive rating, pulse width limited by maximum junction temperature.

[3] Pulse width $\leq 380\mu\text{s}$; duty cycle $\leq 2\%$.

Typical Characteristics

Figure 1. Maximum Power Dissipation vs. Case Temperature

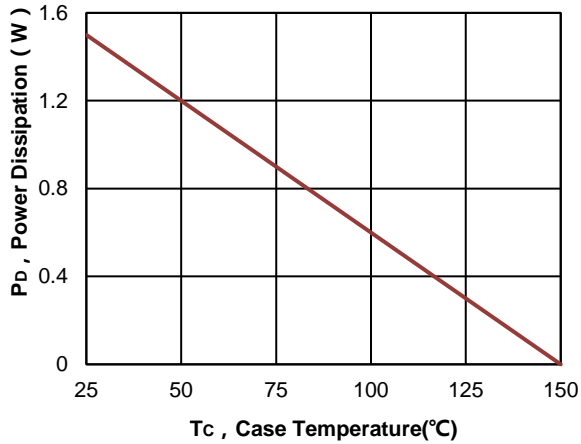

Figure 2. Maximum Continuous Drain Current vs Case Temperature

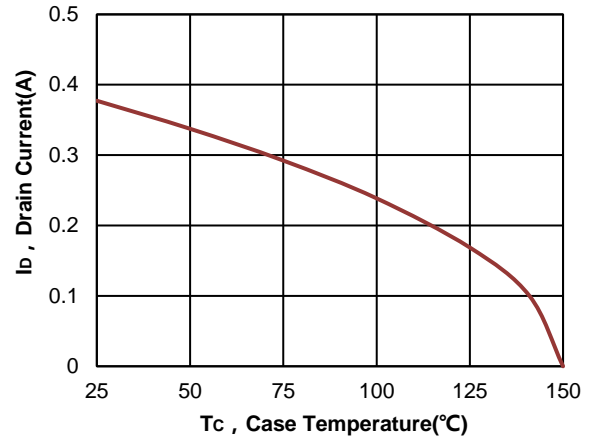

Figure 3. Typical Output Characteristics

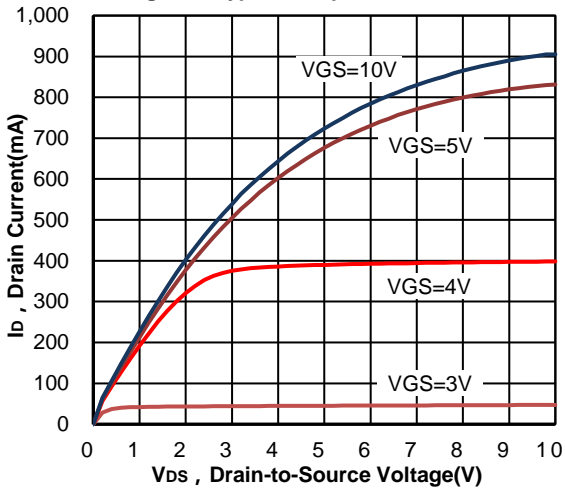

Figure 4. Typical Transfer Characteristics

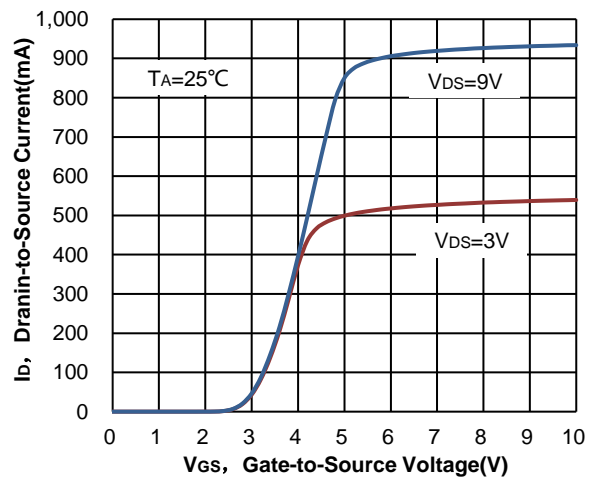

Figure 5. Typical Drain-to-Source On-Resistance vs. Junction Temperature

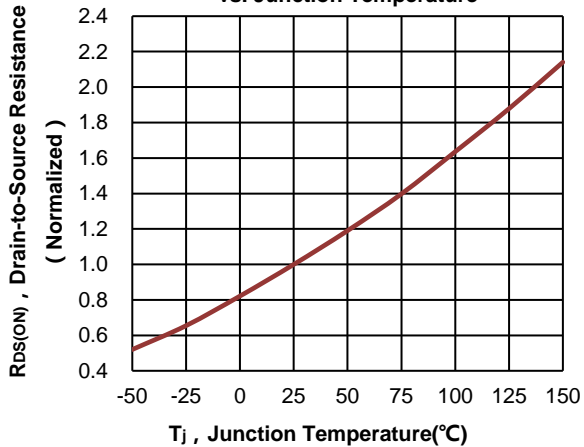

Figure 6. Typical Breakdown Voltage vs. Junction Temperature

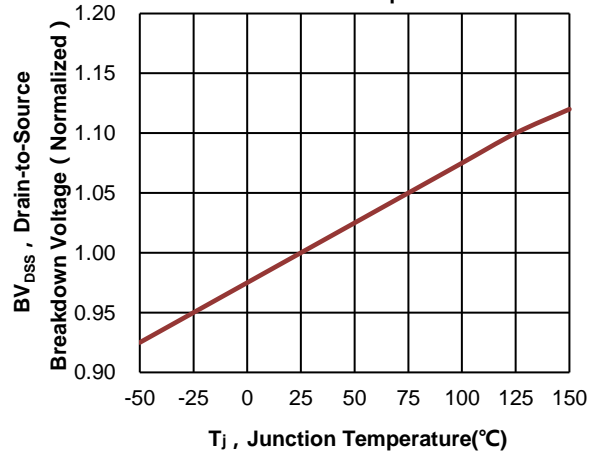
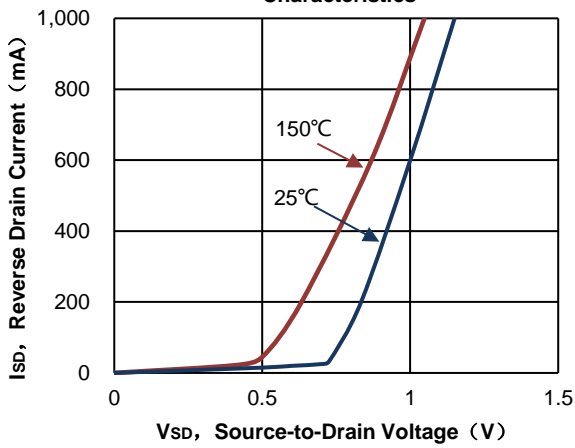
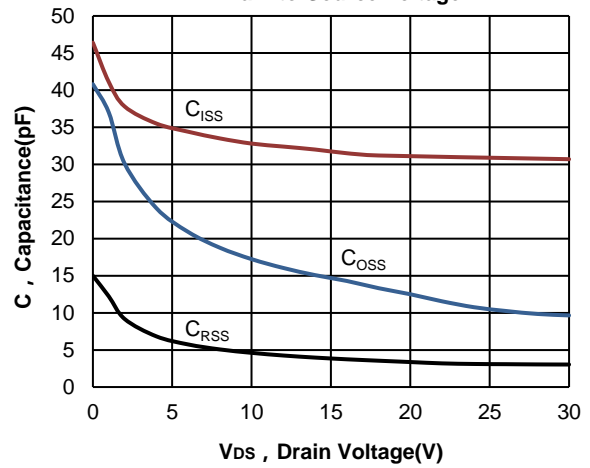
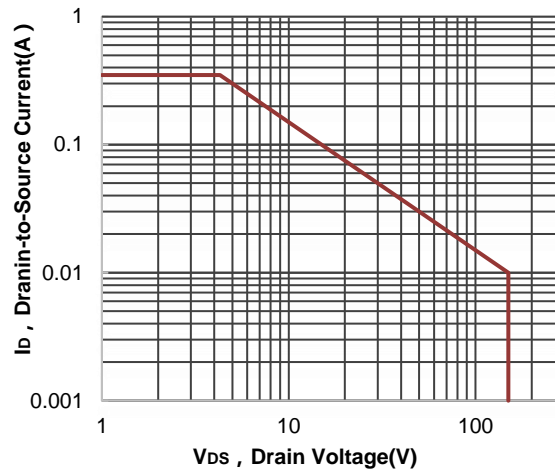
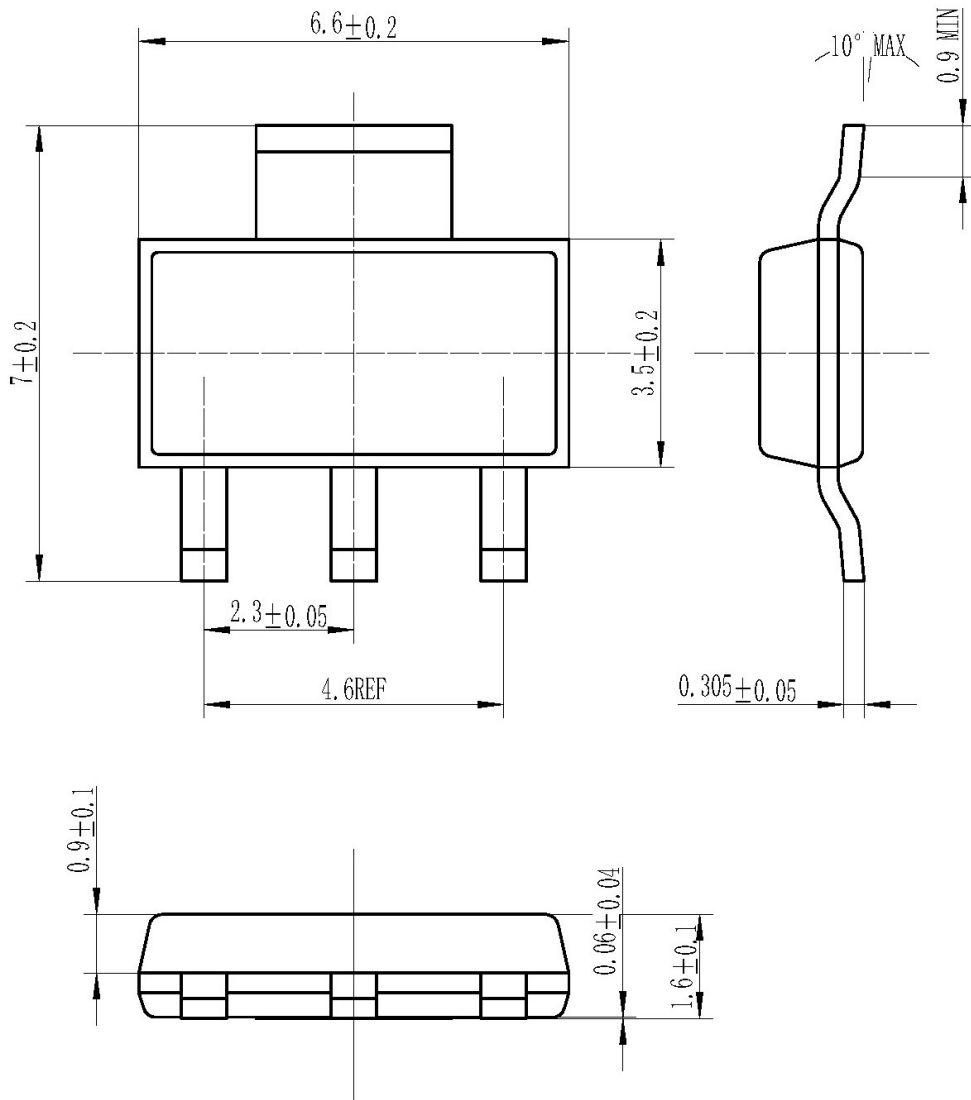

Figure 7. Typical Body Diode Transfer Characteristics

Figure 8. Typical Capacitance vs. Drain-to-Source Voltage

Figure 9. Maximum Forward Safe Operating Area

Package Dimensions**SOT-223**

Published by**ARK Microelectronics Co., Ltd.****ADD: D26,UESTC National Science Park No. 1 Shuangxing Avenue, Chengdu, Sichuan.****All Rights Reserved.****Disclaimers**

ARK Microelectronics Co., Ltd. reserves the right to make change without notice in order to improve reliability, function or design and to discontinue any product or service without notice. Customers should obtain the latest relevant information before orders and should verify that such information is current and complete. All products are sold subject to ARK Microelectronics Co., Ltd's terms and conditions supplied at the time of order acknowledgement.

ARK Microelectronics Co., Ltd. warrants performance of its hardware products to the specifications at the time of sale, Testing, reliability and quality control are used to the extent ARK Microelectronics Co., Ltd deems necessary to support this warrantee. Except where agreed upon by contractual agreement, testing of all parameters of each product is not necessary performed.

ARK Microelectronics Co., Ltd. does not assume any liability arising from the use of any product or circuit designs described herein. Customers are responsible for their products and applications using ARK Microelectronics Co., Ltd's components. To minimize risk, customers must provide adequate design and operating safeguards.

ARK Microelectronics Co., Ltd. does not warrant or convey any license either expressed or implied under its patent rights, nor the rights of others. Reproduction of information in ARK Microelectronics Co., Ltd's data sheets or data books is permissible only if reproduction is without modification or alteration. Reproduction of this information with any alteration is an unfair and deceptive business practice. ARK Microelectronics Co., Ltd is not responsible or liable for such altered documentation.

Resale of ARK Microelectronics Co., Ltd's products with statements different from or beyond the parameters stated by ARK Microelectronics Co., Ltd. for the product or service voids all express or implied warranties for the associated ARK Microelectronics Co., Ltd's product or service and is unfair and deceptive business practice. ARK Microelectronics Co., Ltd is not responsible or liable for any such statements.

Life Support Policy:

ARK Microelectronics Co., Ltd's products are not authorized for use as critical components in life devices or systems without the expressed written approval of ARK Microelectronics Co., Ltd.

As used herein:

1. Life support devices or systems are devices or systems which:
 - a. are intended for surgical implant into the human body,
 - b. support or sustain life,
 - c. whose failure to perform when properly used in accordance with instructions for use provided in the labeling, can be reasonably expected to result in significant injury to the user.
 2. A critical component is any component of a life support device or system whose failure to perform can be reasonably expected to cause the failure of the life support device or system, or to affect its safety or effectiveness.
-